

VERDERFLEX[®]



Peristaltic Cased Tube Pumps

Operating Manual

Verderflex Vantage 3000 P

EZ / S10 / R3i

Version 3.1v-12/2015

Print-No. 01



VERDER
passion for pumps



Version 3.1v-12/2015
Print-No. 01

Vantage 3000 P
EZ / S10 / R3i



The information in this document is essential for the safe operation and servicing of Verderflex Vantage 3000 pumps. This document must be read and understood thoroughly prior to installation of unit, electrical connection and commissioning.

Table of contents

<ul style="list-style-type: none"> 1. About this document <ul style="list-style-type: none"> 1.1 Key features 1.2 Keypad Keys, symbols and key combinations 2 Warranty 3 Pump returns 4 'EC' Declaration 5 Safety <ul style="list-style-type: none"> 5.1 Intended use 5.2 Prevention of obvious misuse 6 Maintenance 7 Pump head options and installation <ul style="list-style-type: none"> 7.1 Types of pump head 7.2 EZ head <ul style="list-style-type: none"> 7.2.1 Key features 7.2.2 Installing the tube 7.2.3 Replacing the pump head 7.2.4 Stacking pump head 7.3 S10 head <ul style="list-style-type: none"> 7.3.1 Key features 7.3.2 Installing the tube 7.4 R3i head <ul style="list-style-type: none"> 7.4.1 Key features 7.4.2 Installing the tube 7.4.3 Changing rotor – R3i head 8 Functions <ul style="list-style-type: none"> 8.1 Adjust flow rate 8.2 Update tube size 8.3 Adjust pump speed 8.4 System calibration 8.5 Runback (Anti-drip) 8.6 Maximum function feature 8.7 Single dose function 8.8 Speed ramp function 8.9 Multi cyclic dosing 8.10 Batch function 8.11 Save dose settings to PROG 1 8.12 Save dose settings to PROG 2 – 10 8.13 Recall saved dose setting 8.14 Memory dose function 8.15 Keypad lock function 8.16 Analogue / digital remote interface 8.17 IP66 Remote speed control 8.18 Pause function 	<ul style="list-style-type: none"> 9 Software installation 10 Menu Tree <ul style="list-style-type: none"> 10.1 Save settings 10.2 Reload settings 11 Remote interface <ul style="list-style-type: none"> 11.1 Manual mode 11.2 Memo-dose mode 11.3 Dose mode 11.4 Batch mode 12 Declaration of conformity according to EC Machine Directive
--	--

Keypad Keys, symbols and Key combinations



















Symbol	Meaning	Symbol	Meaning
	Start CW		Counter clock wise
	Start CCW		Clock wise
	Scroll up		Select tube size
	Scroll down		Set flow rate
	Stop		Set RPM
	Press		Set dose parameters
	Caution		Calibrate
	Press and hold down		Enter
	See		Maximum

Table 1 Keypad Keys and symbols







Symbol	Meaning
	Run Back (Anti-Drip) OFF/ON Press and hold down FLOW then press CAL
	Calibrate SAVE/RECALL Press and hold down CAL then press ENTER
	Batch Facility SET number of Doses Press and hold down MAX then press DOSE
	Speed Ramp OFF/ON Press and hold down UP then press RPM
	Save Dose settings Press and hold down UP then press DOSE

Table 2 Keypad Key combinations

1. About the product

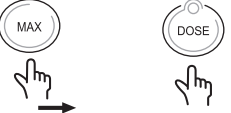
 The Verderflex Vantage 3000® range of peristaltic pumps deliver highly accurate and repeatable flow rates with a quick and easy setup. Vantage 3000 P is a programmable, easy tube load pump with a stackable pump head and requires low maintenance.

1.1 Key features

- Microprocessor controlled 24 hour duty with brushless dc motor
- Set precise dose requirement and calibrate to suit medium viscosity
- Stackable and multi channel head options
- Keypad operated with two line alpha numeric display.
- Volt free contacts for external Start/Stop/Reverse
- Manual/ analogue/Computer control of speed/flow rate
- Store 10 settings (jobs) for easy start up
- Memory Dose
- Speed Ramp (Soft Start) Facility
- Keypad Lock
- Computer link – up with RS232
- Windows™ based application programming.

2. Warranty

 The manufacturer does not accept any liability for damage resulting from disregard of this documentation.

This product is guaranteed to be free from defects in material or workmanship for a period of 24 months from date of purchase, excluding consumable items such as cartridges, tubing or rollers. Products out of guarantee period will be repaired for a nominal charge.

3. Pump returns

 All returned pumps must be decontaminated before being returned. The Decontamination Certificate is separately requested and must be returned before or with the pump delivery. For your protection, items returned must be carefully packed to prevent damage in transit and insured against loss.

4. 'EC' Declaration

 The Vantage 3000® P range, complies with EMC 2004/108/ EC as well as Machine Directive 2006/42/EC.

Installation of this pump into other equipment must be in accordance with relevant Directives/Standards and be carried out by a suitably competent person.

5. Safety

 The manufacturer does not accept any liability for damage resulting from disregard of this documentation.

5.1 Intended use

- Only use the pump to handle compatible fluids as recommended by the manufacturer.
- Adhere to the operating limits.
- Consult the manufacturer regarding any other use of the pump.

5.2 Prevention of obvious misuse

- Note the operating limits of the pump with regard to temperature, pressure, flow rate and motor speed.
- Do not operate the pump while the inlet/outlet valve is closed.
- Only install the pump as recommended in this manual. For example, the following are not allowed:
 - Installing the pump without proper support.
 - Installation in the immediate vicinity of extreme hot or cold sources.
- Do not use in conjunction with life support equipment
- Do not connect pump to the human body

 **DANGER**

Risk of electrocution!

- ▶ Make sure that the electrical information on the rating plate agrees with the power supply.
- ▶ Isolate the main supply before replacing the tube /cartridge
- ▶ Isolate the main supply before removing the enclosure cover

6. Maintenance



Motor and Gearbox are lubricated for life and should not require attention. Rotor rollers are self-lubricated. Pump tubing will not last forever; establish suitable tube replacement schedule to prevent inconvenient tube failure.

This pump contains no user serviceable parts and is factory sealed to confirm integrity. Pump warranty will be invalidated if the seal is broken.



Figure 1 Tamper proof lable

7. Installation

- Pump should be installed by suitably qualified personnel
- Pump should be sited on stable horizontal surface
- Allow free flow of air around pump
- Tube should not be allowed to kink.

7.1 Types of pump head

 Verderflex® Vantage 3000 P pumps are available with the S10 pump head featured on the Verderflex Smart tube pump, as well as the R3i head featured on the Verderflex Rapide tube pump providing greater flow rates with stackable and multi channel head options.

		
1. EZ Head	2. R3i Head	3. S10 Head

Table 3 Vantage 3000 P pump head options

7.2 EZ head

7.2.1 Key features

Easy tube change system, stackable multi head options with Verderprene, Silicone, Viton® or Tygon® tubing.

- Flow rates up to 1,310 ml/min (20.8 US GPH)
- Pressures up to 2 Bar (29 PSI)
- Typically used in frequent tube change applications

7.2.2 Installing the tube

1. Flip the lugs on both sides of the pump head to lift the top section
2. Once the head is lifted as shown in figure, insert the tube over the rollers.
3. Flip the lugs on both sides of the pump head to lock the top section down.
 - Adjust the tube clamp to hold the tube in place and avoid slip
 - Adjust the tube clamp on both sides of the pump head to the tube diameter.
 - If a tube slip is observed, tighten the tension on the clamps
 - Alternately, if a reduced flow is observed, reduce the clamp tension.

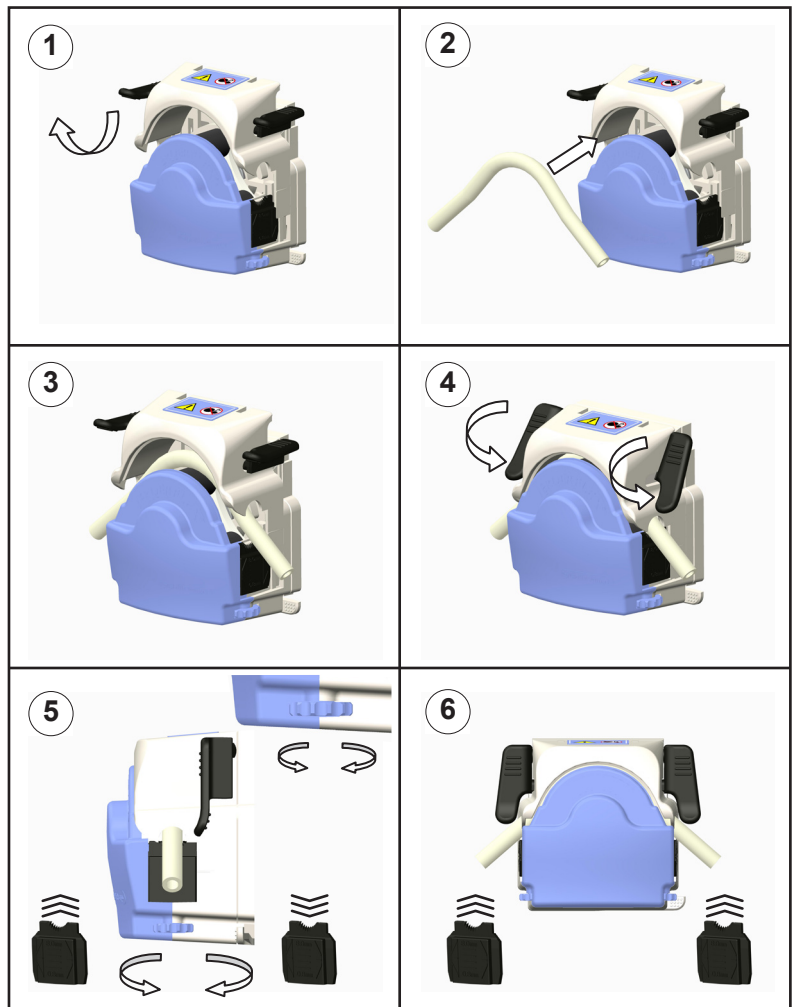

Table 4 Installing the tube

7.2.3 Replacing the pump head – EZ head

1. Offer pump head to backplate at angle locating drive shaft and rotor shaft with pump head at approx 45° to vertical, locating backplate lugs in housing.
2. Push and twist until location lever clicks into position
3. Remove by depressing location lever and twisting pump head counter clockwise 45°

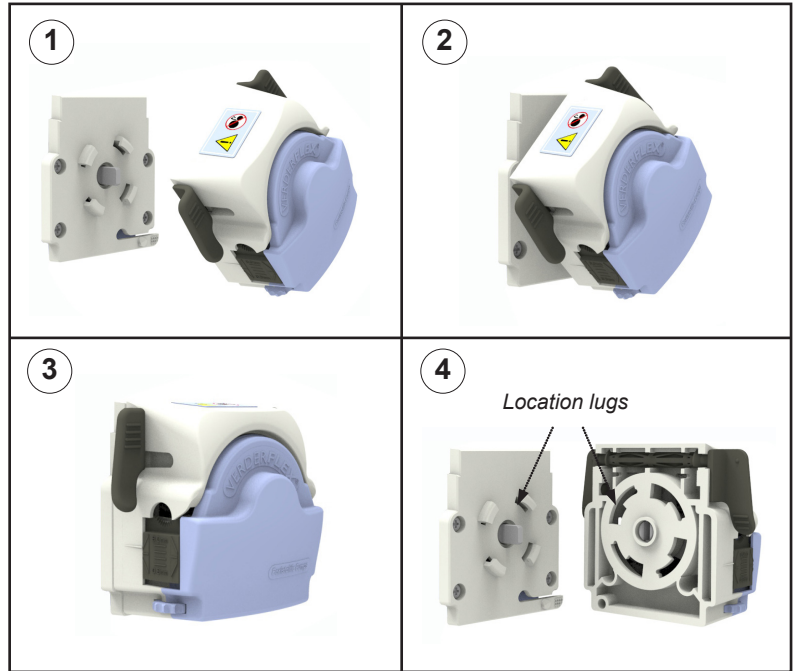



Table 5 Replacing pump head – EZ head

7.2.4 Stacking pump head – EZ head

 A pump head can be stacked over a similar stackable head as demonstrated in table 6.

1. Attach the stackable head on to the backplate (refer 7.2.3)
2. Offer the pump head over the stackable head locating the drive shaft and pump shaft with pump head at approx 45° to vertical, locating lugs in the housing.
3. Push and twist unit location lever clicks into position.
4. Remove by depressing location lever on the stackable head and twisting pump head counter clockwise 45°.

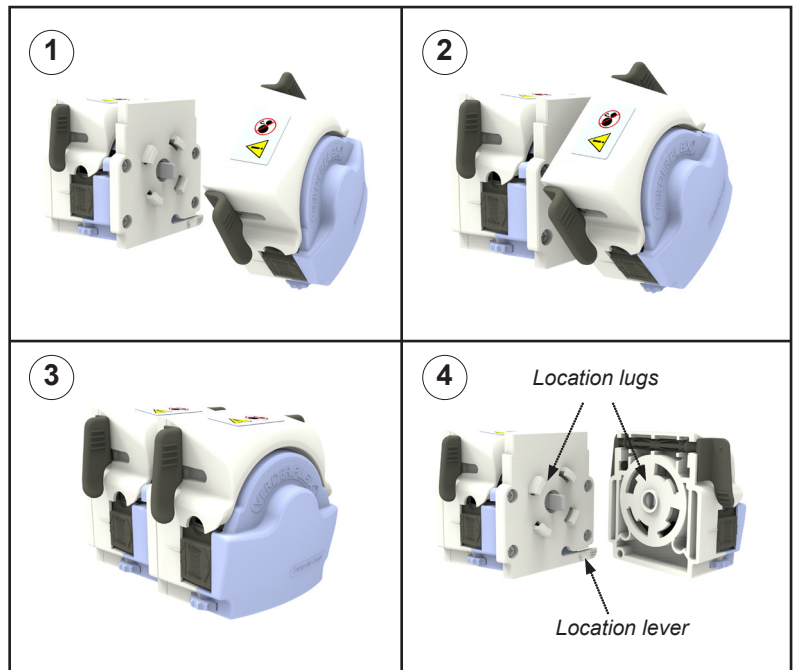



Table 6 Stacking – EZ head

7.3 S10 Head

7.3.1 Key features

 Taken from the Verderflex Smart tube pump design. The S10 includes a quick tube change, ergonomic design for ease of use.

- Flow rates up to 1,780 ml/min (28 US GPH)
- Pressures up to 2 Bar (29 PSI)
- Multi channel options
- Typically used in:
 - Chemical dosing
 - Industrial fluid transfer
 - Heavy duty environments

7.3.2 Installing the tube

1. Insert tube on top of the rollers
2. Fit the saddle to one set of dowels
3. Open up the lever and fit the claw over
4. Push the lever down to lock the saddle into place over the other set of dowels

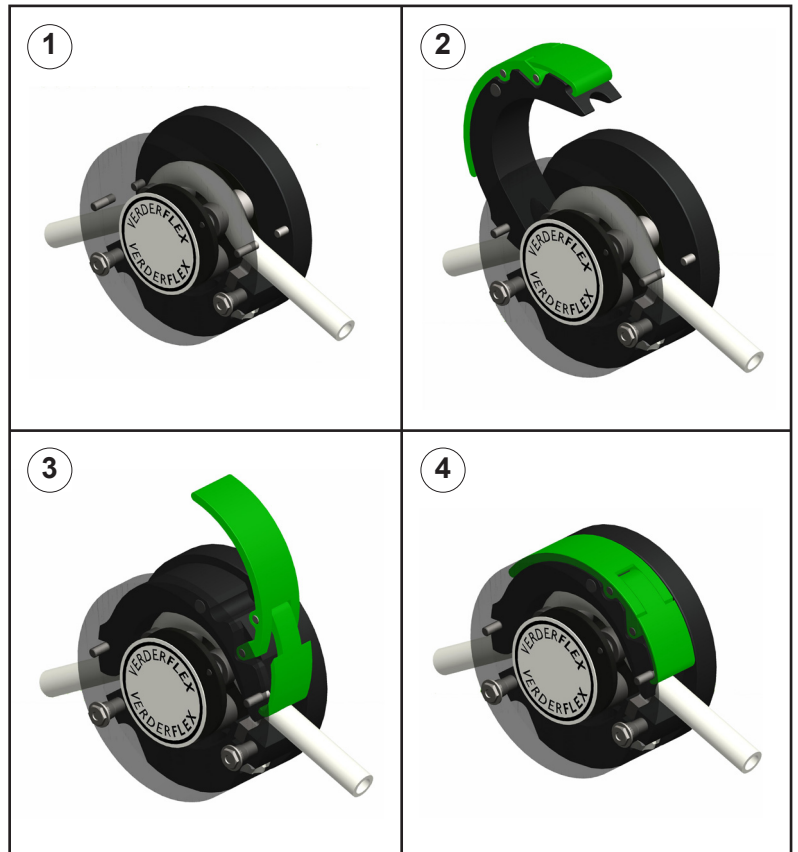



Table 7 Installing tube – S10 head

7.4 R3i head

7.4.1 Key features

 Robust design with thick wall tube for suction and pressure handling.

- Flow rates up to 3,250 ml/min (51.5 US GPH)
- Pressures up to 2 Bar (29 PSI)
- Typically used in:
 - Printing production
 - Dispensing
 - Industrial detergent applications

7.4.2 Installing the tube

1. Remove the clamp, but leave the front cover in place
2. Run the pump at low speed and carefully feed tube through the inlet
3. When tube reach outlet, use blunt end rod to guide the tube out.
4. Fit tube clamp loosely, and position tube with marked lines adjacent to edge of pump housing and tube clamp.
5. Tighten the tube clamp securely

7.4.3 Changing rotor – R3i head

1. Align grub screw hole with flat on shaft
2. Align peak of roller with peak of tube track or set rotor distance back from front of pump housing
3. Fasten grub screw securely

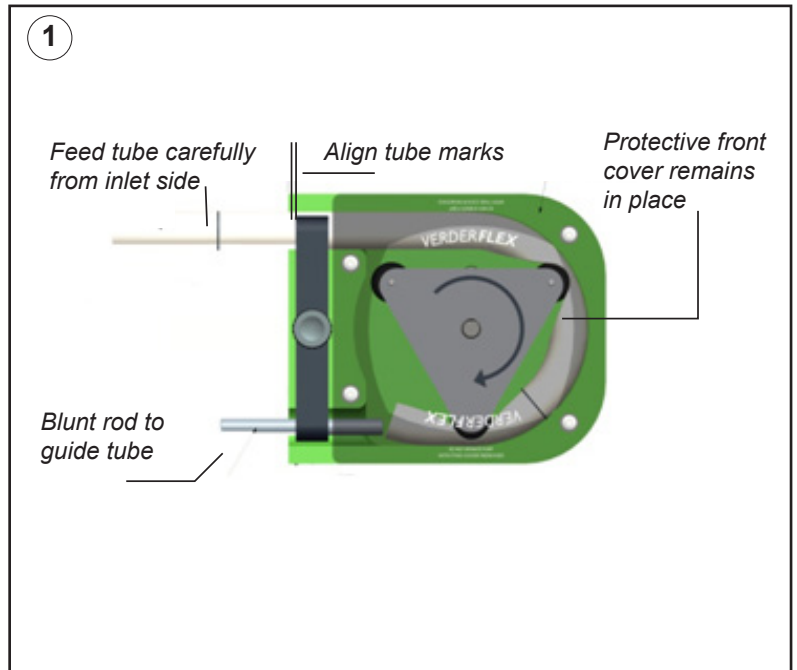

Table 8 Installing tube – R3i head

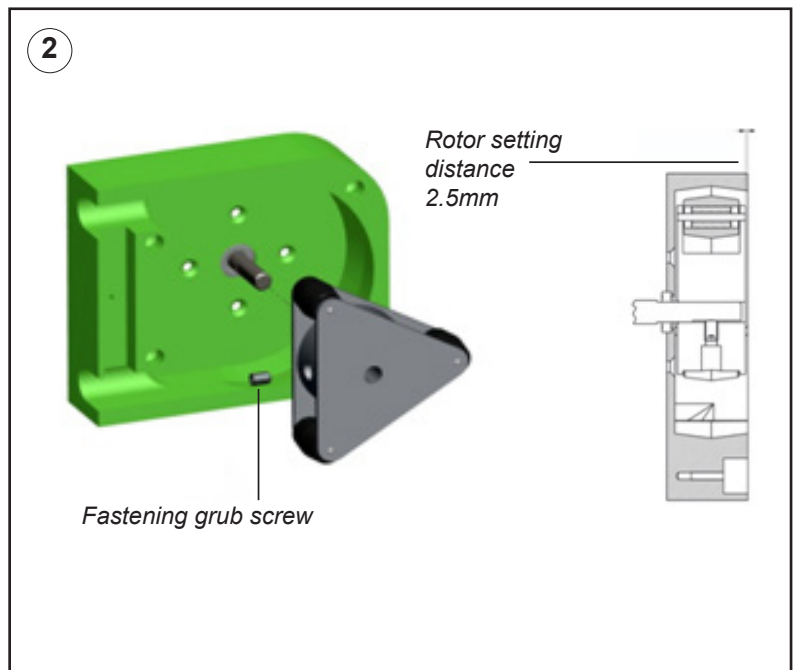
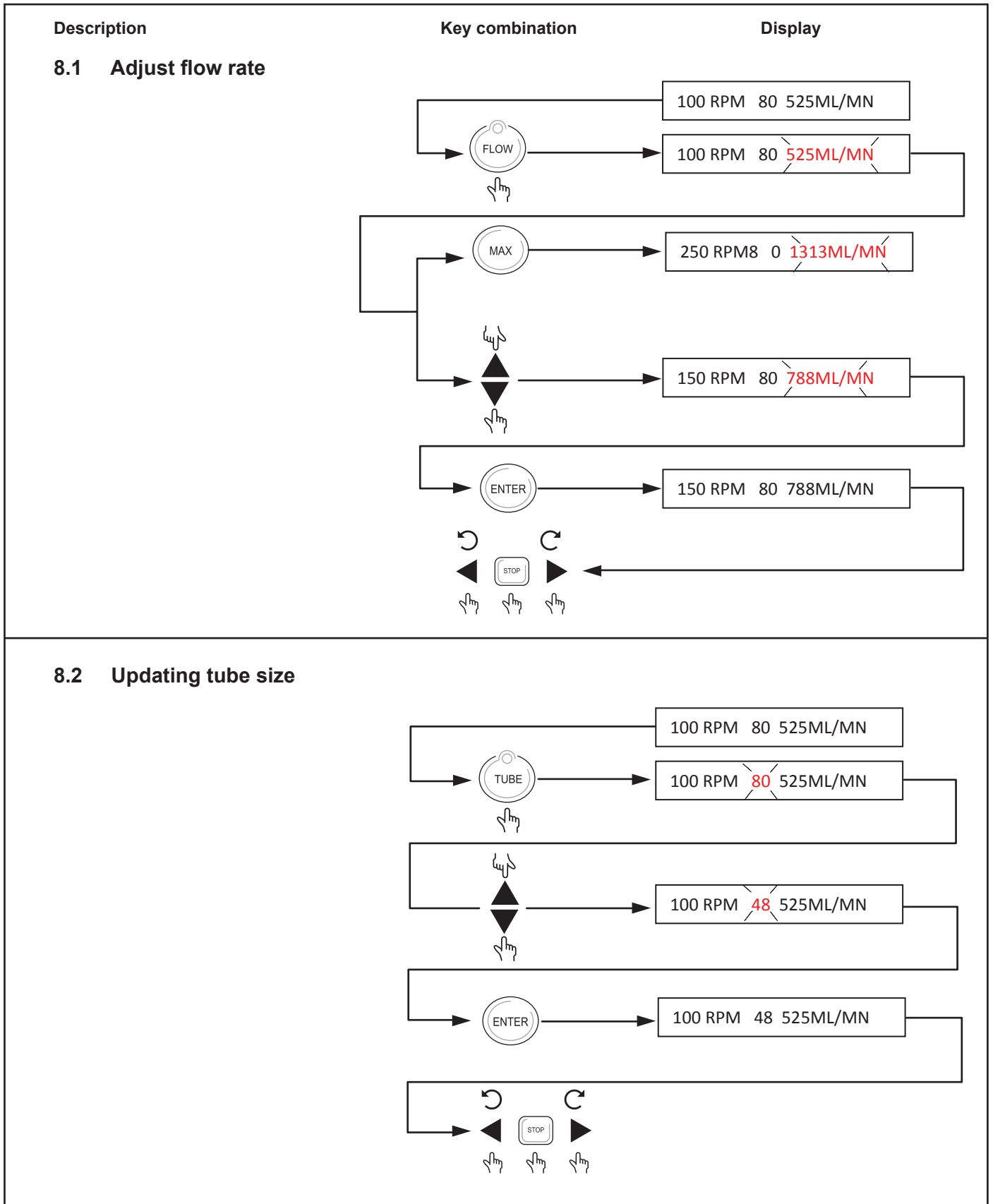
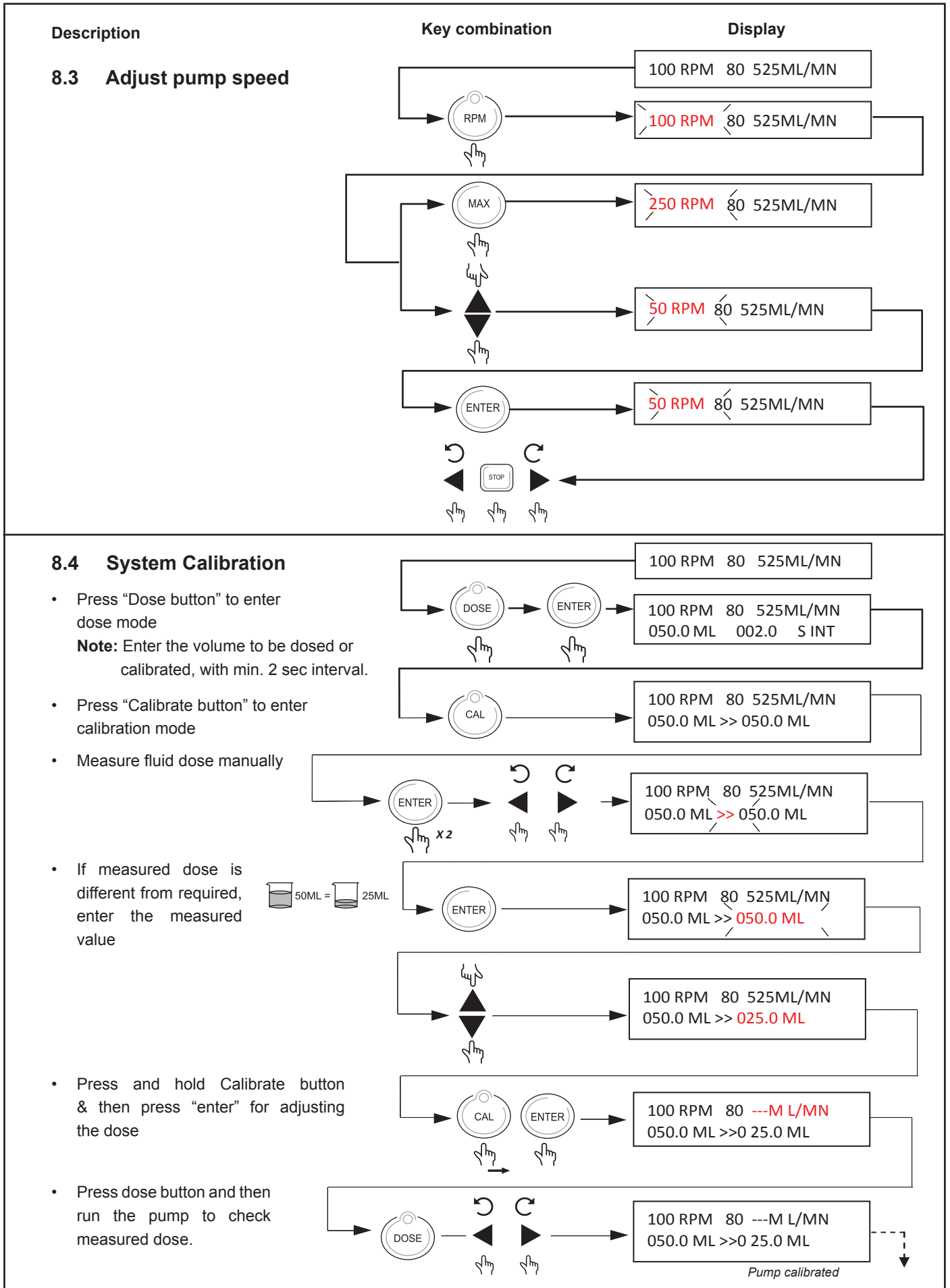
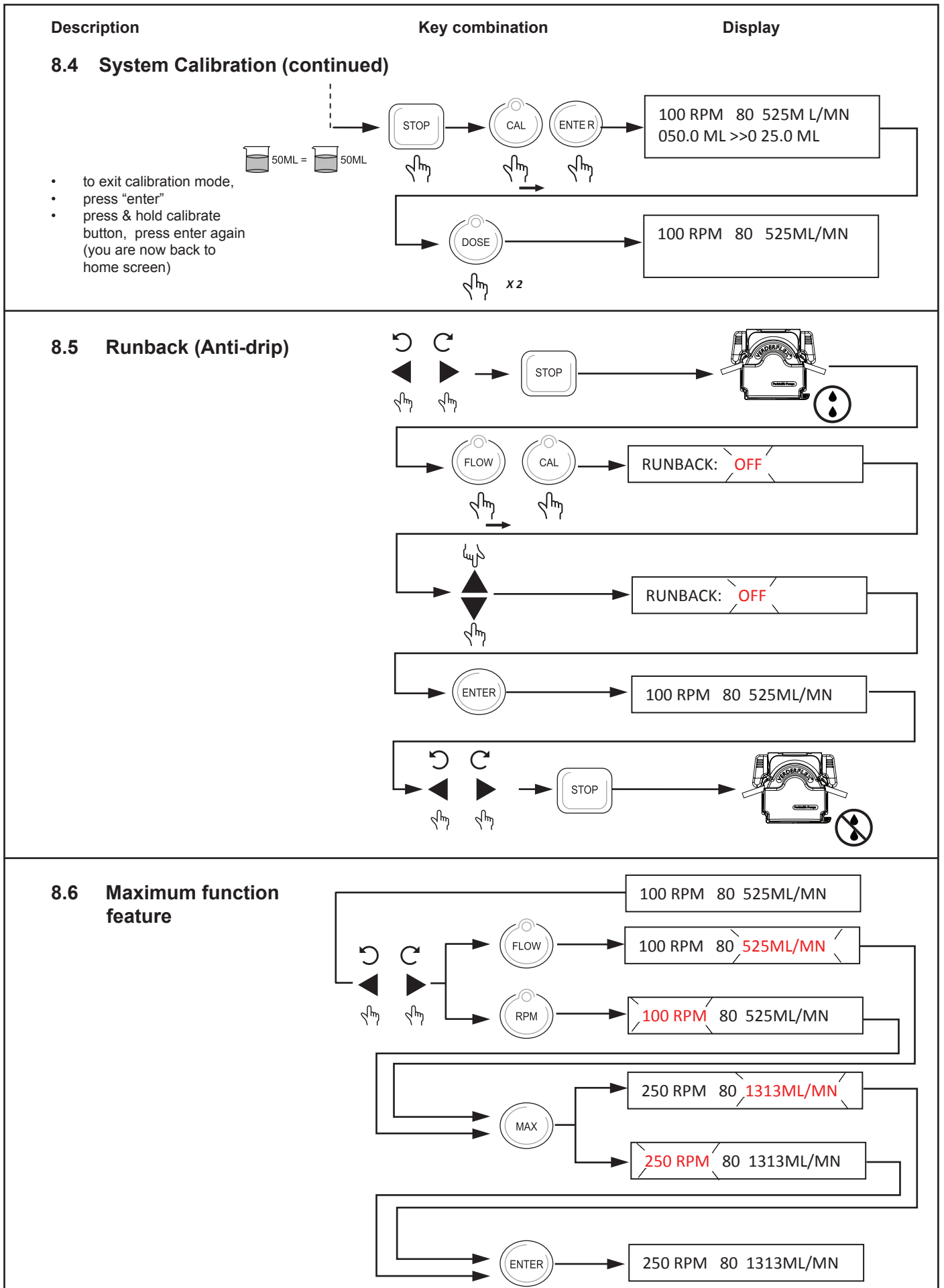

Table 9 Replacing the rotor – R3i head

8. Functions







Description

8.9 Multi cyclic dosing

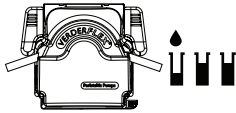

Key combination

Display

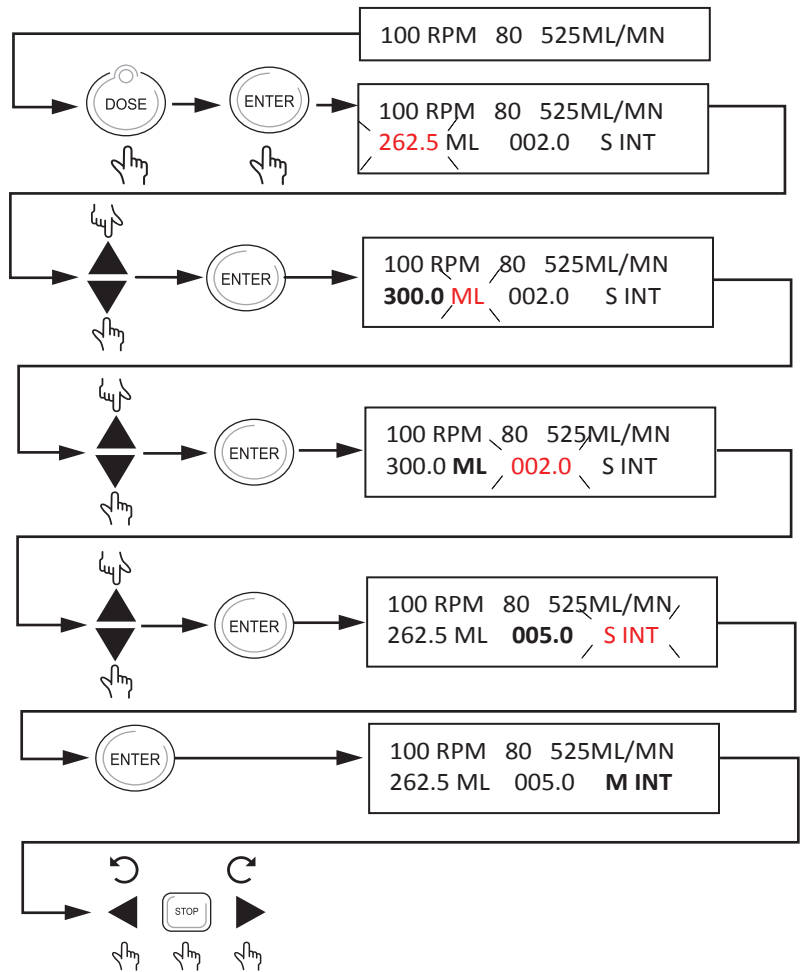

8.10 Batch function

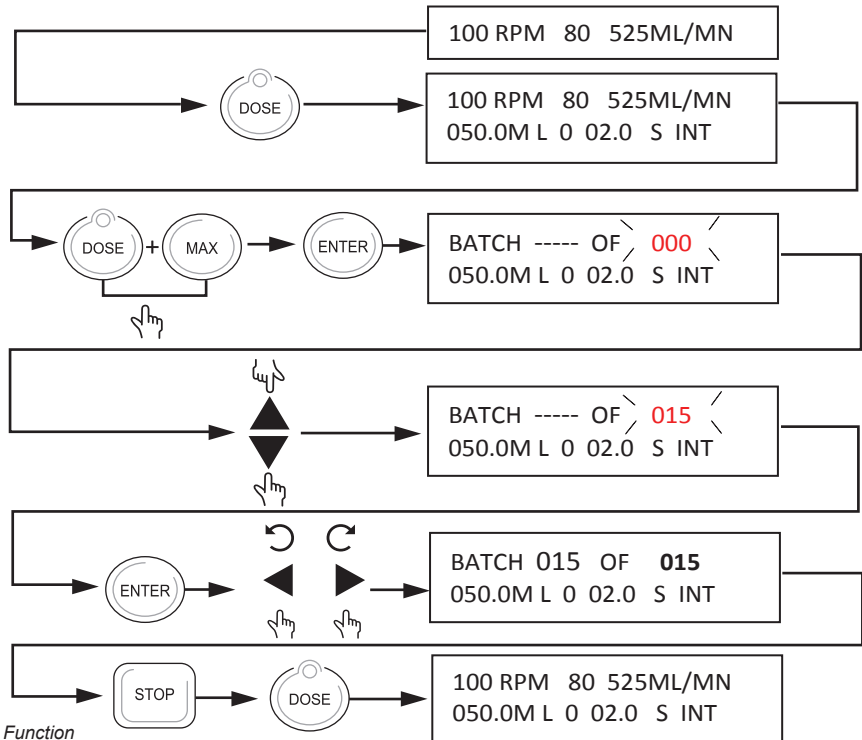
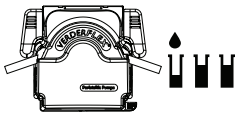

Note: Dose and Max button has to be pressed together, at the same time to activate Batch function

Exit Function

Description

8.11 Save dose settings to PROG 1

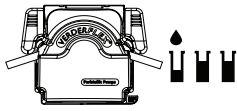

Key combination

Display

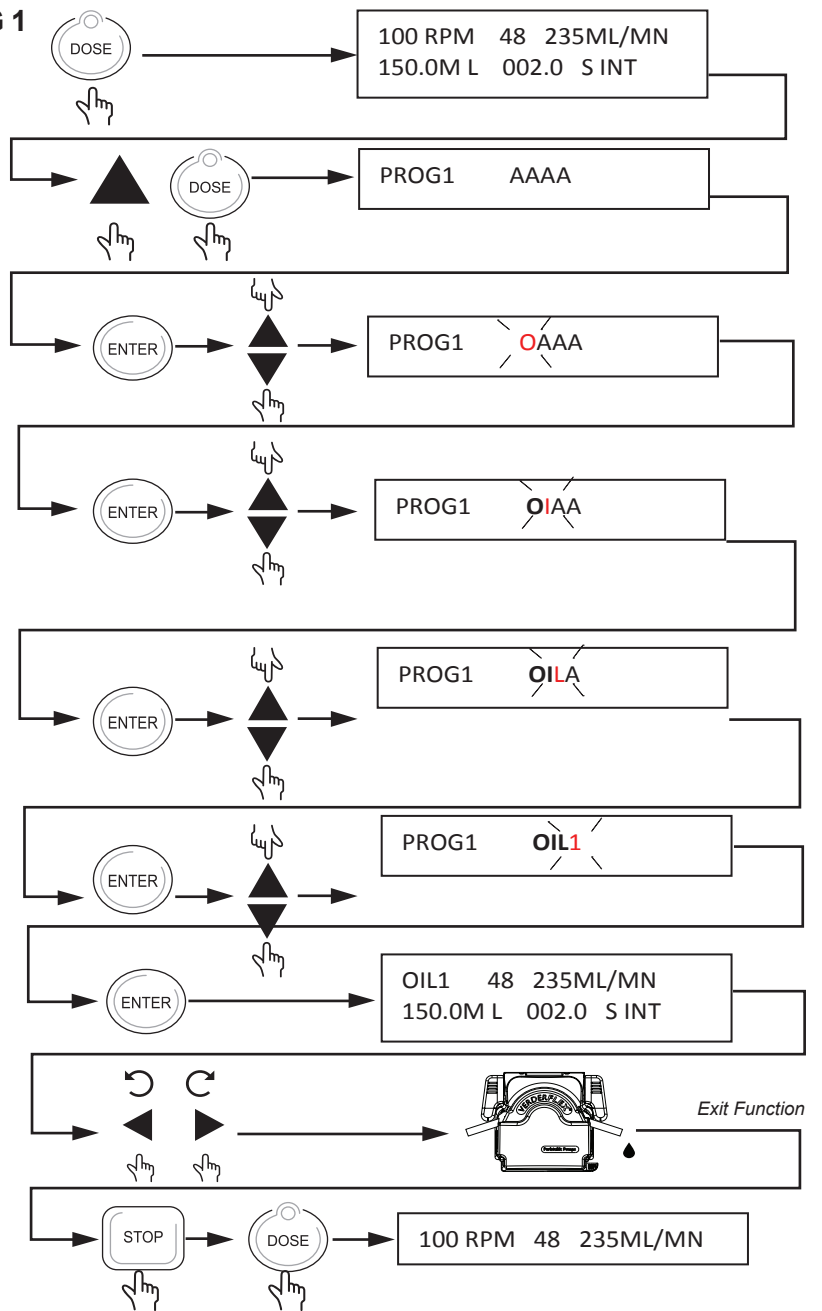

8.12 Save dose settings to PROG 2 - 10

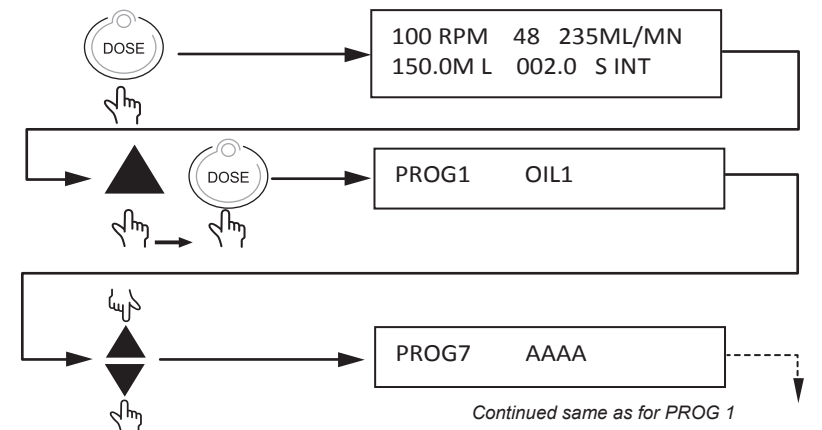
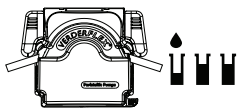

Description

8.13 Recall saved dose setting

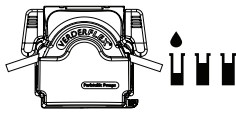

Key combination

Display

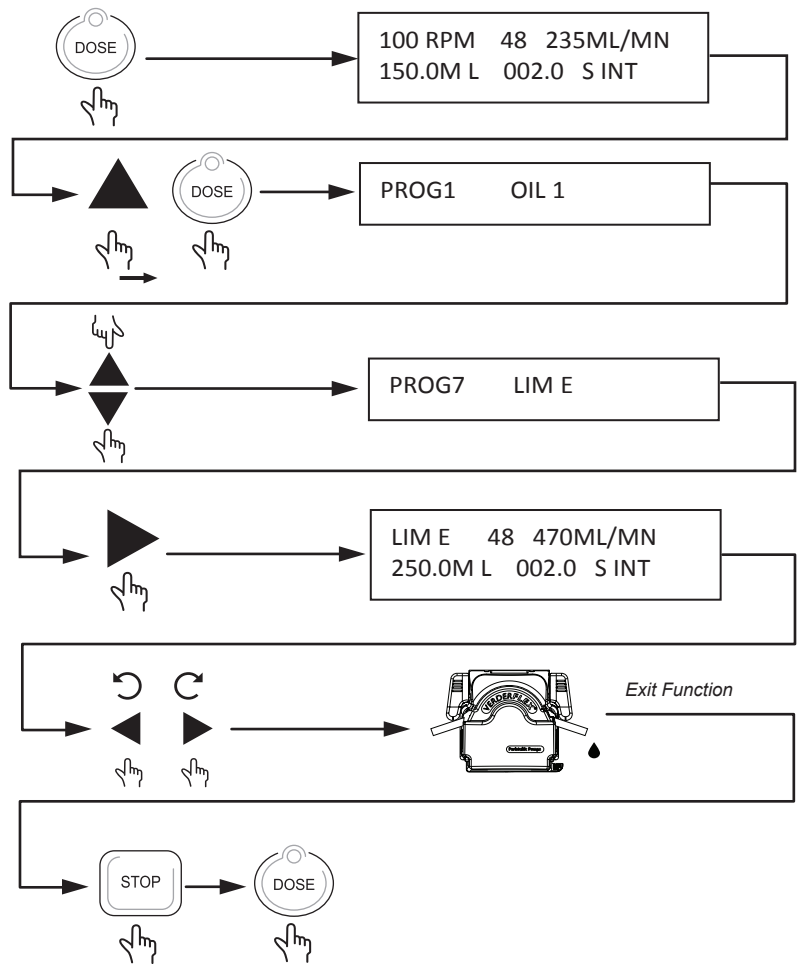

8.14 Memory dose function

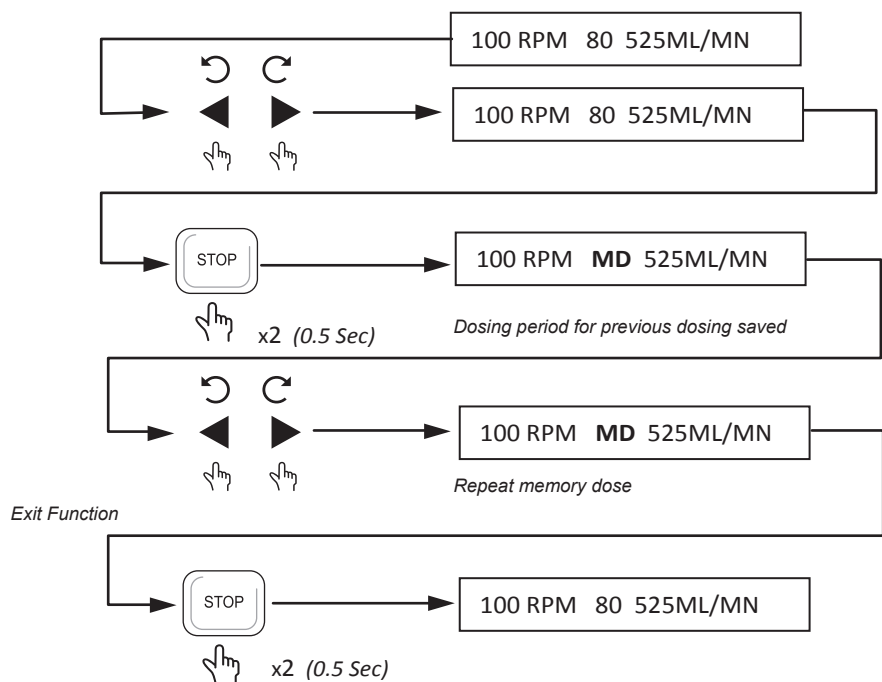

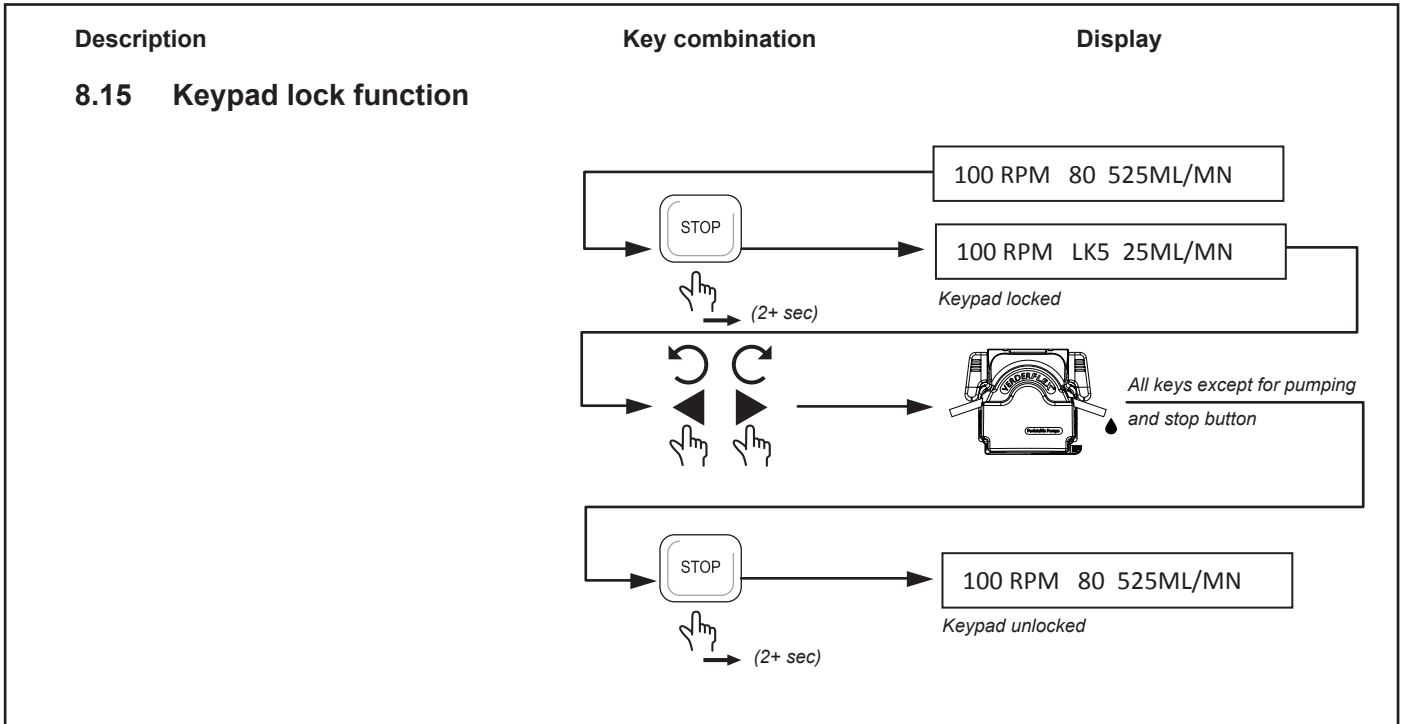

8.16 Analogue /Digital Remote Interface

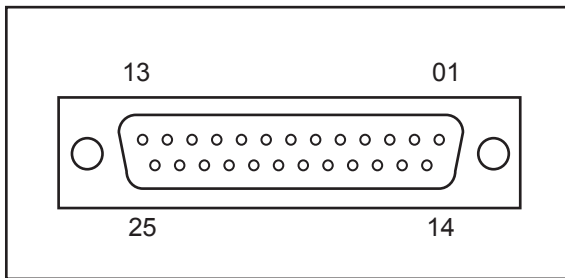
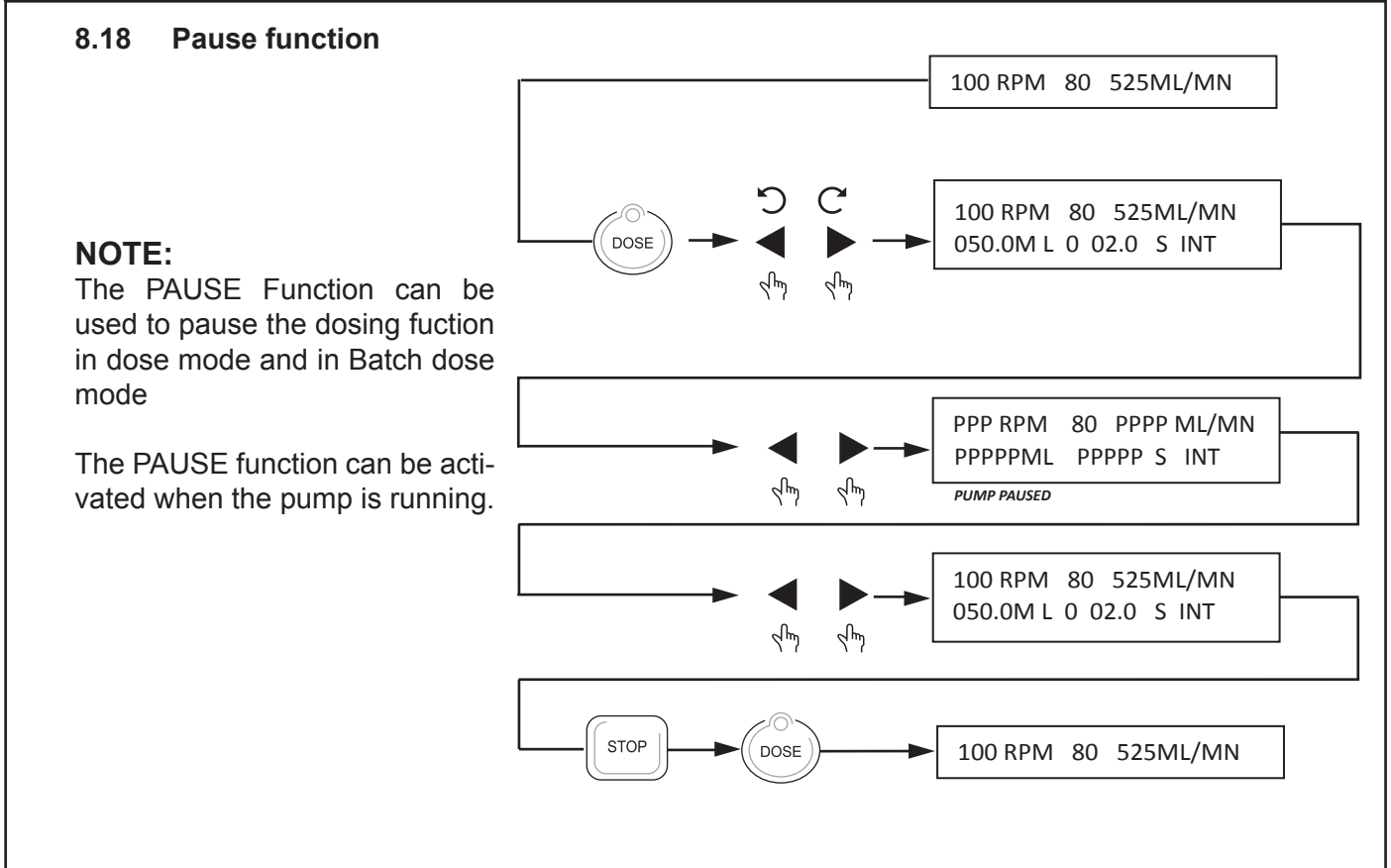
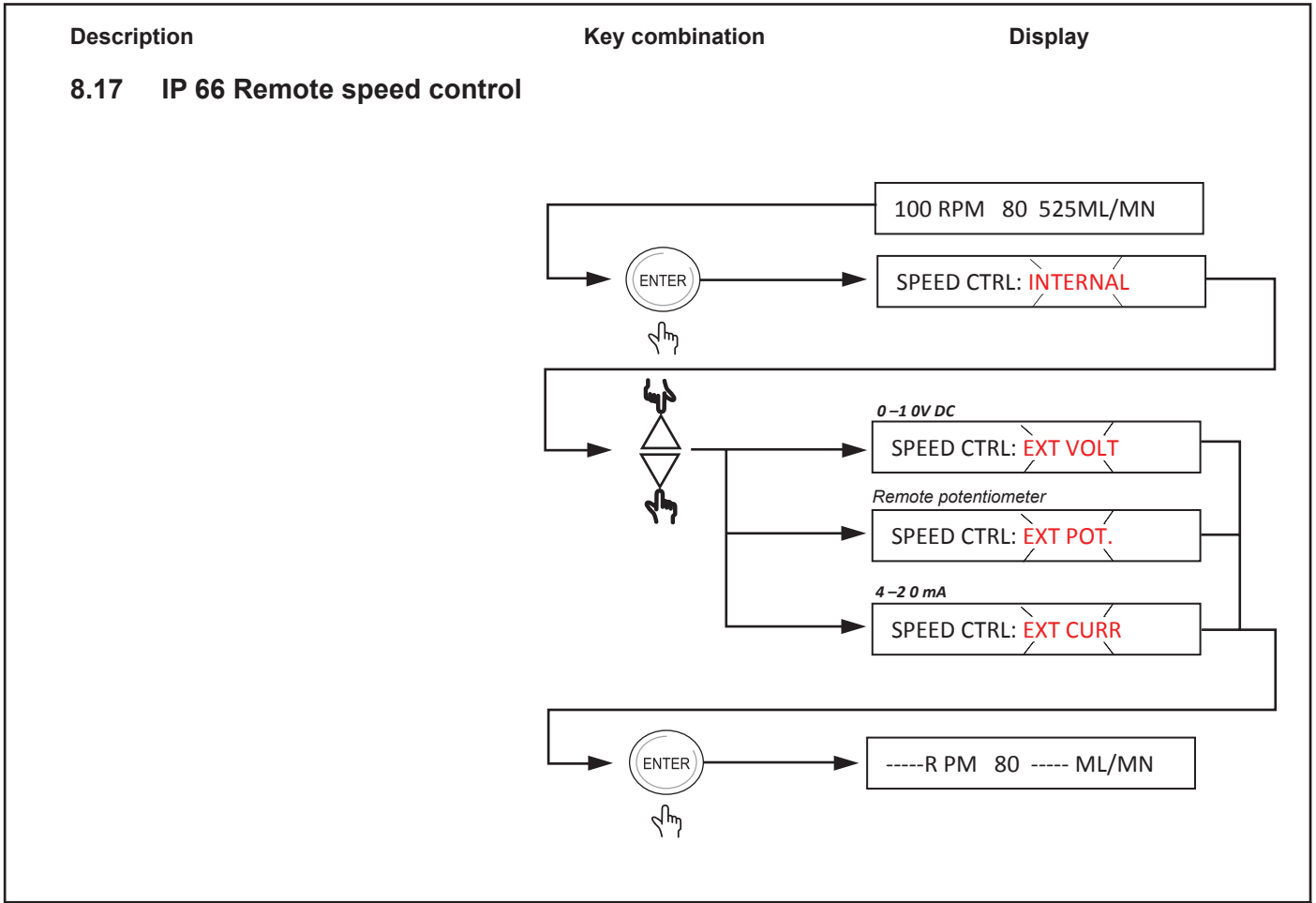

Fig .2 25 way 'D' type connector (Remote control lead P/N: AU E1973

PIN	Function
14	pump running +5V out
15	pump stopped +5V out
21	pump running GND
22	pump stopped GND

	Function	Connection
Clockwise 	Started CW	6 —○—○— 18
	Stopped CW	6 —○—○— 18
Counter Clockwise 	Started CCW	7 —○—○— 19 6 —○—○— 18
	Stopped CCW	7 —○—○— 19 6 —○—○— 18
IP 66 Remote speed control 	Speed control 0-10V d.c	13 —○— +V 25 —○— GND 10 —○— 10K (0.5W) —○— 23 11 —○— ↑ 12 —○— +V 24 —○— GND

Table 10: Analogue /Digital Remote Interface



9. Software installation

- ▶ Insert the installation disc and open “My computer” from start menu



- ▶ Click and open CD/DVD drive



- ▶ Copy and paste “PCPUMP.exe” onto the desktop or into preferred folder



► Run "PCPUMP.exe"

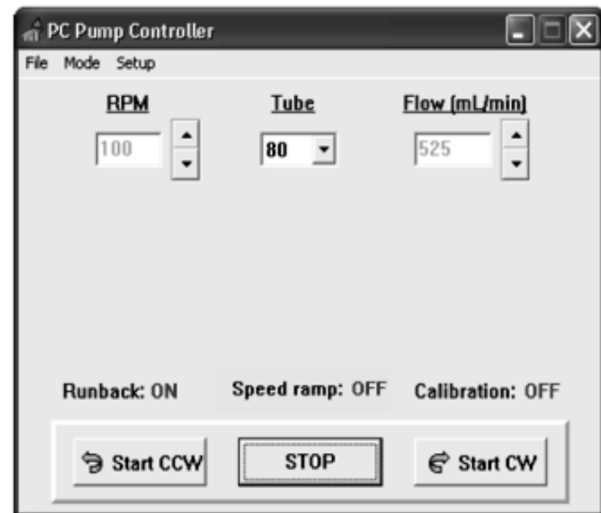

10. Menu Tree

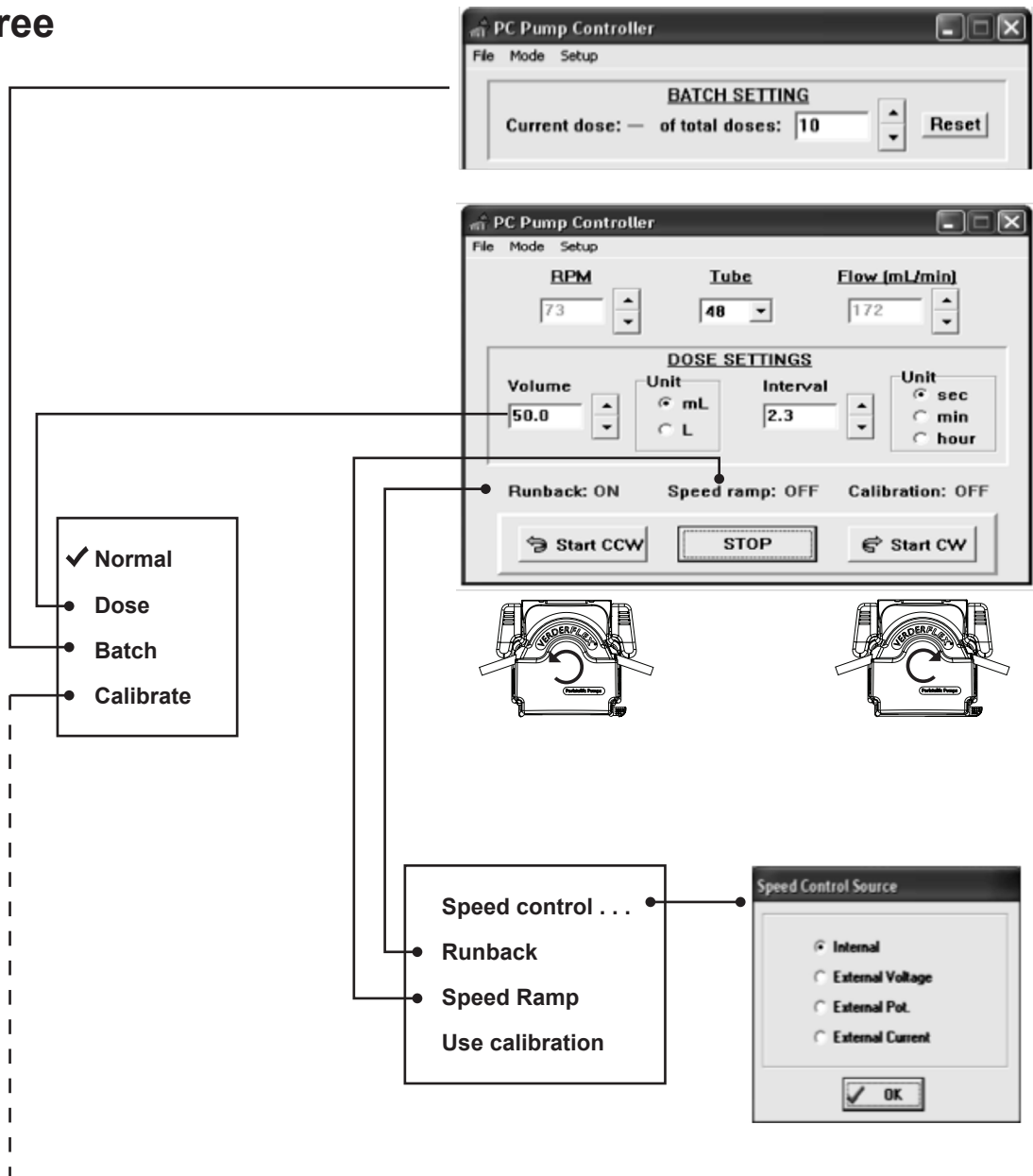

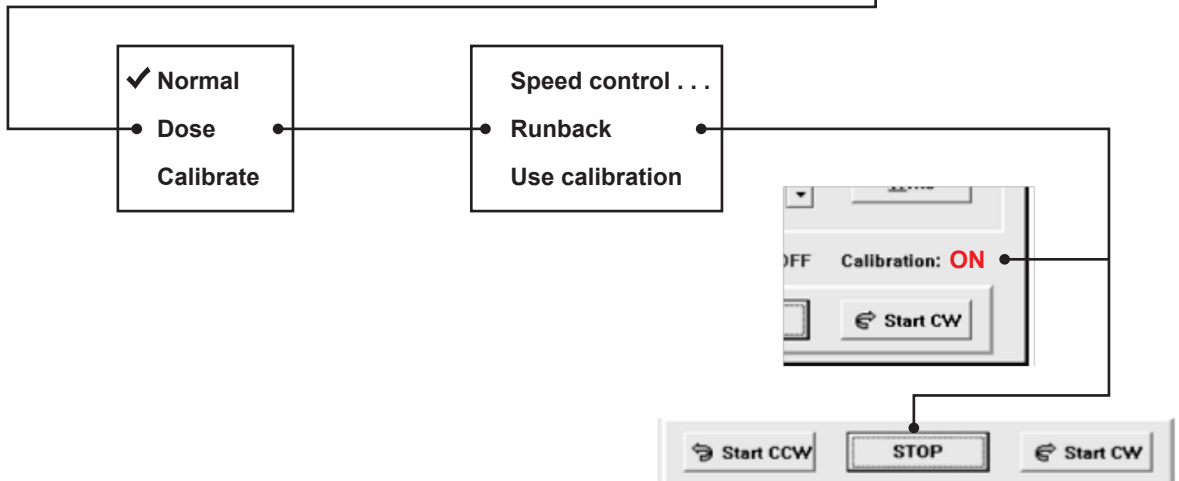
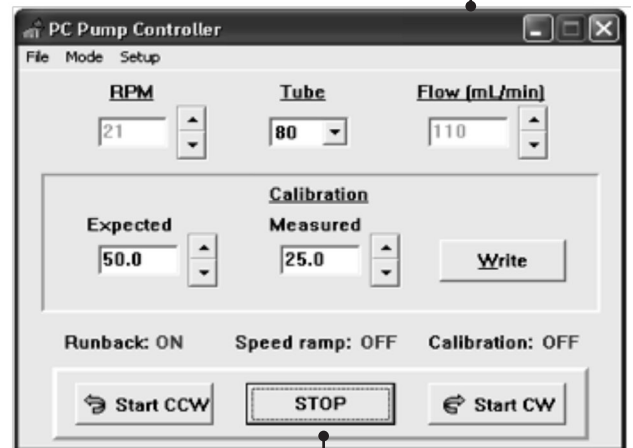
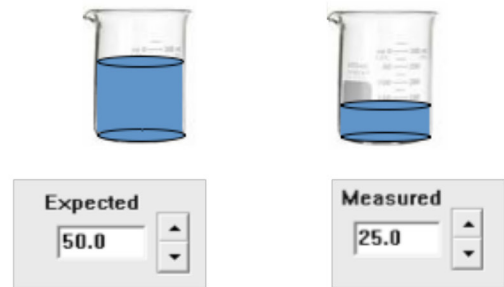
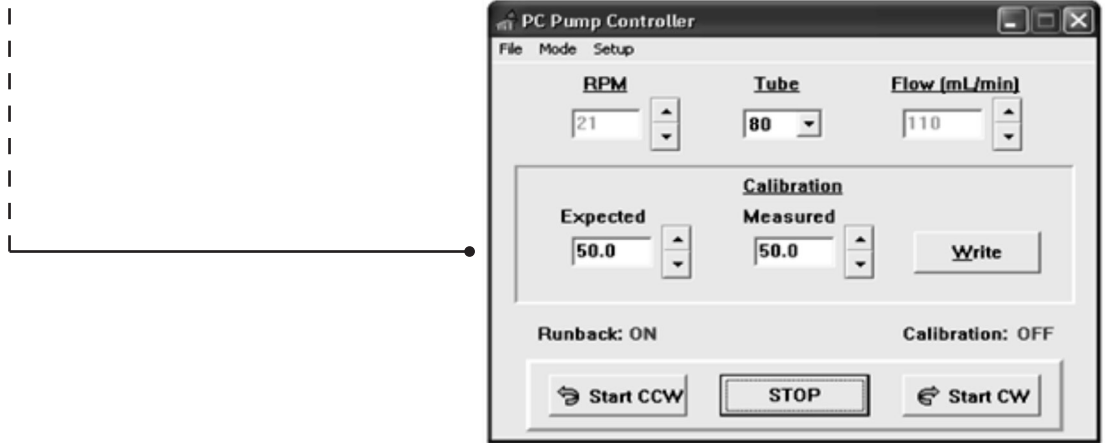

10.1 Save settings

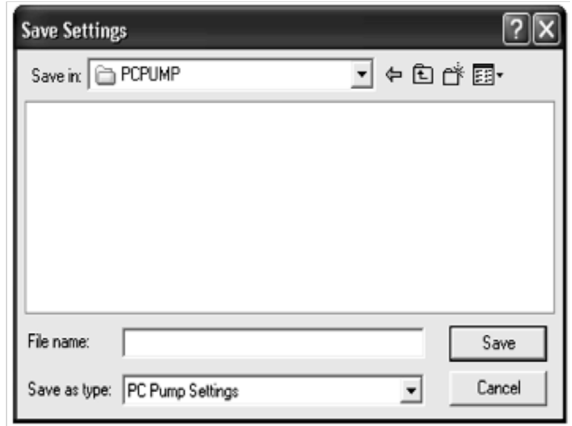
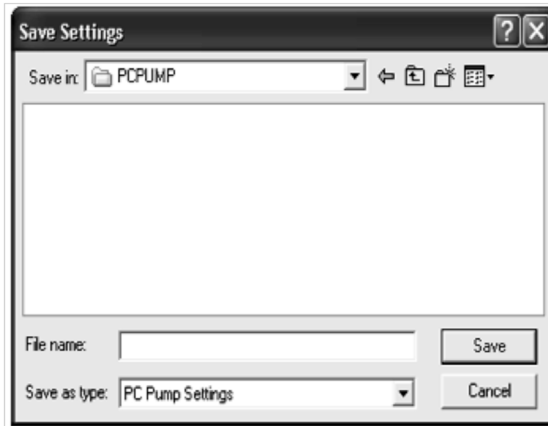
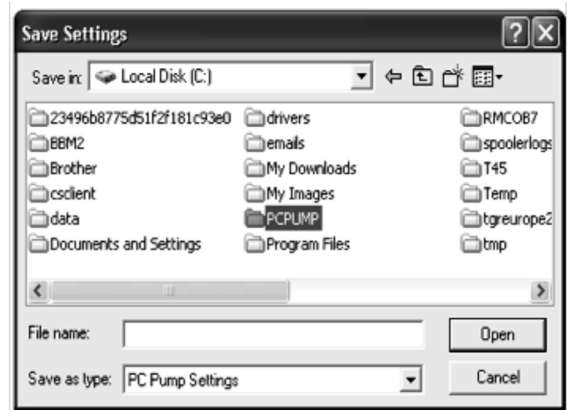
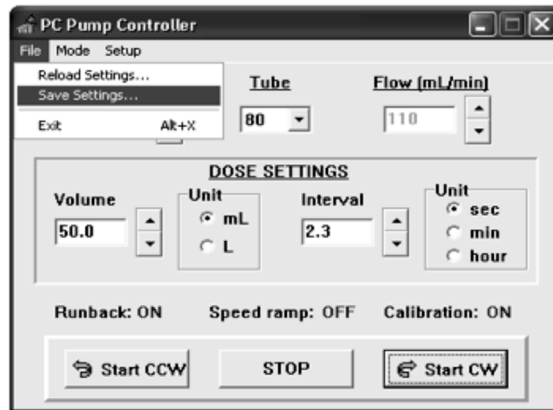

10.2 Reload settings

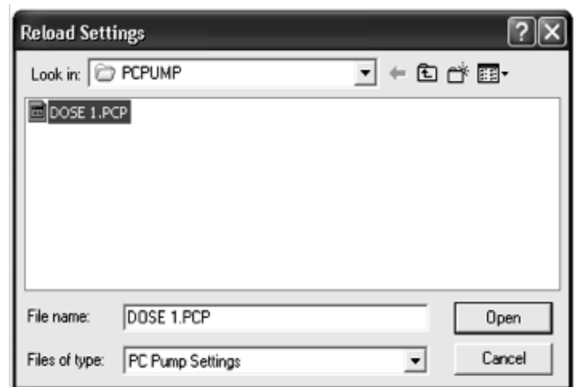
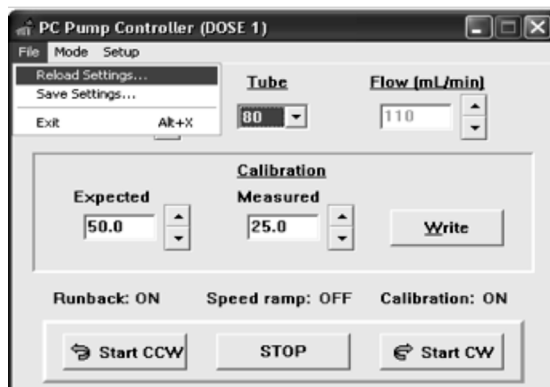

11. Remote Interface

11.1 Manual mode

- Momentarily operate CW or CCW run from keypad and the pump runs until STOP is pressed.
- Momentarily operate CW or CCW run from remote interface and the pump only runs for as long as the input is on. Continuous operation requires the input to be maintained.

11.2 Memo-dose mode

- Momentarily Operate CW or CCW run from keypad and the pump runs for that memo period then stops.
- Momentarily operate CW or CCW run from keypad again and the operation repeats as a “One shot operation”.
- Operate CW or CCW run from remote interface and the pump only runs for as long as the input is on. The input must be maintained throughout the duration of the dose period for the dose cycle to complete. When the Memo-dose has completed, the input must then be unlatched and re-latched again to allow the Memo-dose to restart.

11.3 Dose mode

- Momentarily operate CW or CCW run from keypad and the Dose program repeats indefinitely.
- Operate CW or CCW run from the remote interface and the pump will run the dose cycle then stop at the end of one dose (“One shot”) unless the input is maintained. Maintaining the input allows the dose to repeat indefinitely (“cyclic”)

11.4 Batch mode

- Momentarily operate CW or CCW run from keypad and the batch program runs.
- The batch count decrements automatically when the timeout period of the previous batch count has elapsed.
- Operate CW or CCW run from the remote interface and the pump will dose one batch count then stop at the start of the next batch count, unless the input is maintained. Maintaining the input allows the batch to continue its decrement count until it reaches zero. If the input is not maintained it can be decremented as a “One shot” operation by momentarily tripping the remote input until count = zero.

**(Please Note: Keypad operation has priority over the remote interface)*

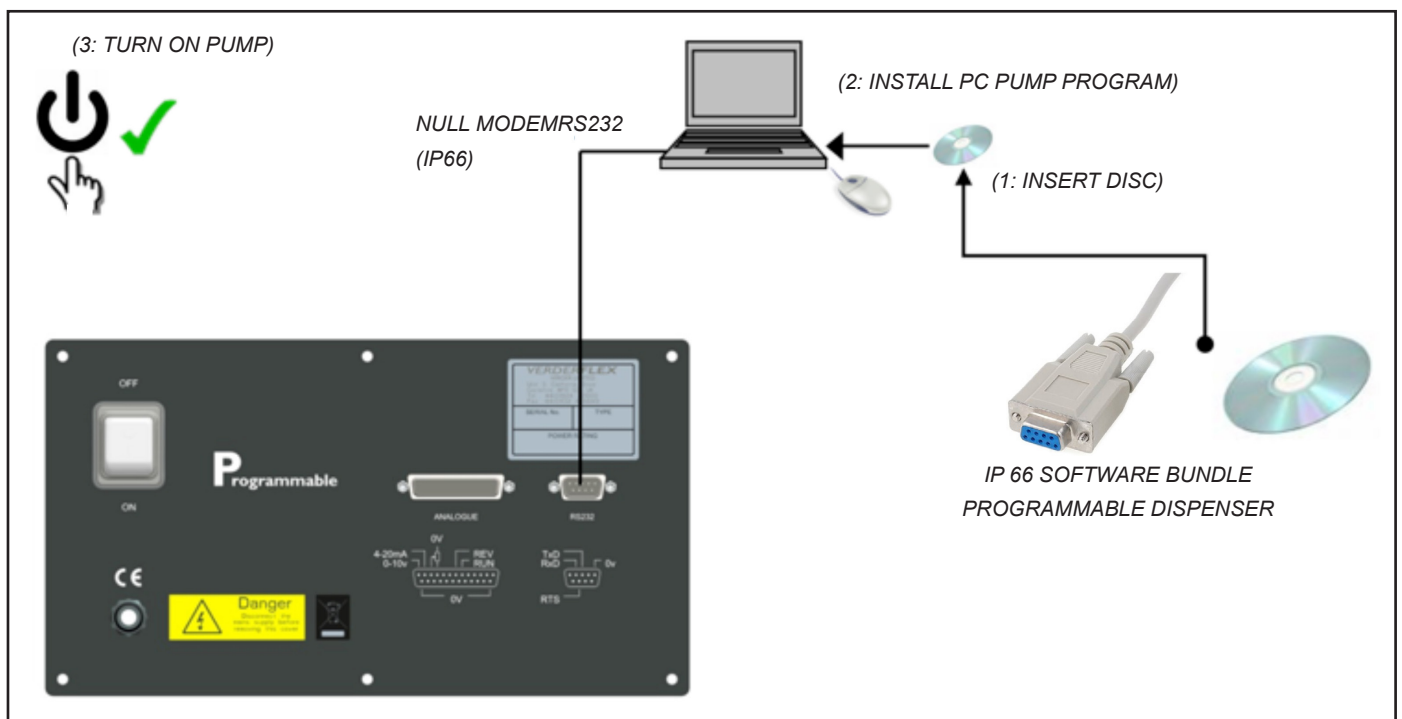

Figure 3 IP66 Computer control

12. Remote Analogue/Digital Control

An external Analogue/Digital control can be used to operate the Vantage 3000 C & P range. Suitable IP66 and RS232 connectors are available for external connections.

12.1 Types of Remote control:

- Foot/Hand switch
- Analogue control:
 - 0 - 10V D.C
 - Remote potentiometer
 - 4 – 20 mA
- RS232 control

12.2 Layout of Back Plate

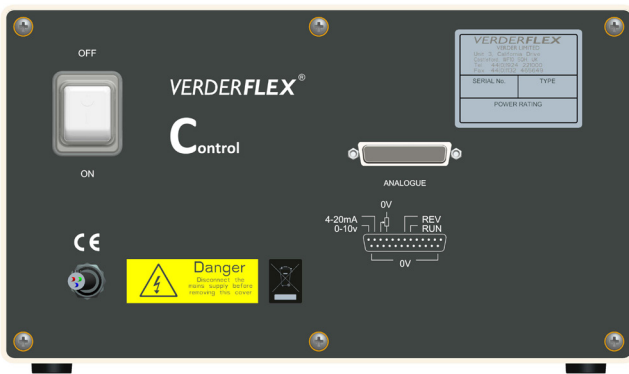

Figure 4: Back plate – Vantage 3000 C

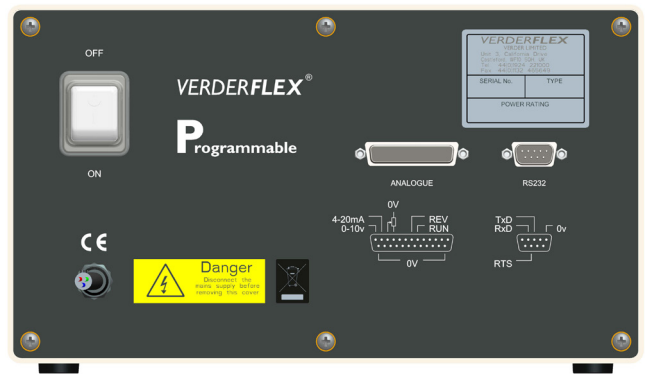

Figure 5: Back plate – Vantage 3000 P

12.3 External controls on different models

The control methods featured on each model are as listed below:

Model	Analogue/Digital Control				RS232 Control
	Footswitch	0-10V d.c	4-20mA	0-5V	
Vantage 3000 B					
Vantage 3000 C	✓	✓	✓	✓	
Vantage 3000 P	✓	✓	✓	✓	✓

Table 11: Models & Control features available

12.4 Analogue Connector:

- Connector Layout

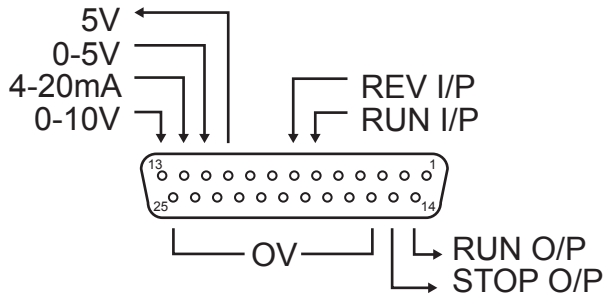

Figure 6: 25 way 'D' type connector

- Connector Description:

PIN	I/O	FUNCTION
6	IN	FORWARD RUN INPUT
7	IN	REVERSE RUN INPUT
10	OUT	5 VOLT SUPPLY (to potentiometer)
11	IN	0-5 VOLTS INPUT
12	IN	4-20mA INPUT
13	IN	0-10 VOLTS INPUT
14	OUT	RUNNING OUTPUT (5V)
15	OUT	STOPPED OUTPUT (5V)
16 to 25	OUT	0 VOLTS (internally connected to zero volts in the pump)

Table 12: Analogue/Digital Connector Pins

12.5 Foot /Hand switch control

Foot switches can be used to remotely turn the pump on and off, freeing the hands to perform other operations or providing ergonomic improvement at a workstation.



Figure 7: Connecting the footswitch

25 way "D" connector

12.5.1 Connecting the foot switch

Connect the footswitch to the port marked “Analogue” of the Vantage 3000. (Refer fig.3)

Only the user can be aware of all conditions and factors present during installation, operation, and maintenance of a foot switch and surrounding work area. Therefore, only the user can determine which footswitches and which point-of-operation safeguards can properly be used in a particular application or work station.

	Function	Connection
	Started CW	6 —○—○— 18
	Stopped CW	6 —○—○— 18
	Started CCW	7 —○—○— 19 6 —○—○— 18
	Stopped CCW	7 —○—○— 19 6 —○—○— 18

Table 13: Pin Function & Connection

12.6 Analogue control

Analogue control can be used to remotely control the pump speed. 0-10V or 4-20mA can be generated by a suitable transducer or a process controller such as a PLC. Potentiometer control utilizes the 5 volt source from pin 10 on the 25way “D” connector and pin 11 as a 0 – 5 volt input as shown in Table 10.

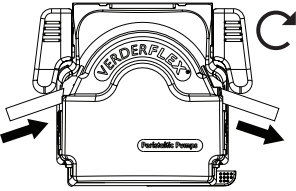
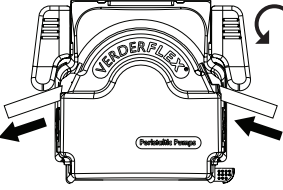
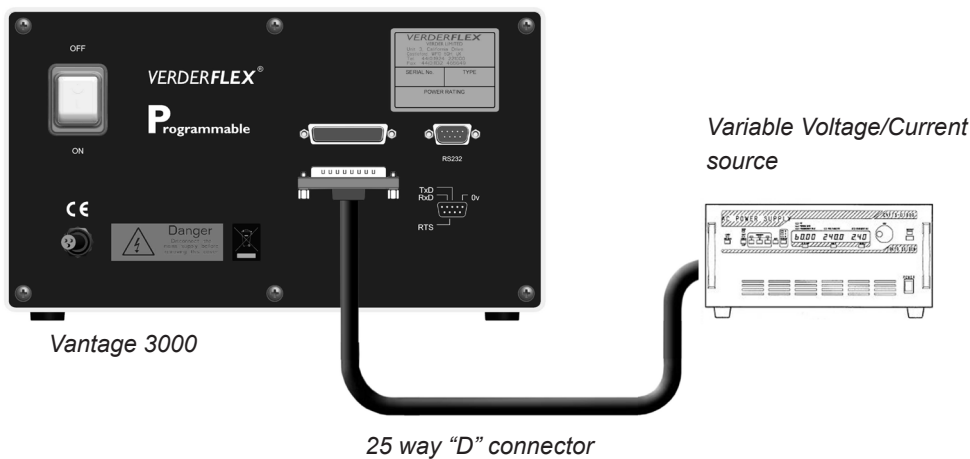

Figure 8: Connecting Variable Voltage/Current source

12.6.1 Connecting analogue control systems:

Connect the analogue control device to the Analogue port of the Vantage 3000 as shown in fig 3.

	Function	Connection
Clockwise 	Started CW	6 ○ —○— 18
	Stopped CW	6 ○ —○— 18
Counter Clockwise 	Started CCW	7 ○ —○— 19 6 ○ —○— 18
	Stopped CCW	7 ○ —○— 19 6 ○ —○— 18
IP 66 Remote speed control 	Speed control 0-10V d.c	13 ○ — +V 25 ○ — GND
	Potentiometer	10K (0.5W) 10 ○ — [] — 23 11 ○ — ↑
	4-20mA	12 ○ — I_{in} 24 ○ — GND

Table 14: Pin connection for analogue control (refer table 2 for pin description)

12.7 Foot /Hand switch control

Verderflex Vantage 3000 pump model “P” has an RS232 computer interface for communication with process controllers and Verderflex PC windows user software. The pump can be connected to a PC/Laptop using a Null Modem serial cable and/or a USB/RS232 convertor. The USB/RS232 convertor is required only if your PC/Laptop is not provided with an RS232 port. Compatible connecting cables required to operate the pump via RS232 can be supplied by Verderflex, upon request.

12.7.1 Connector Layout

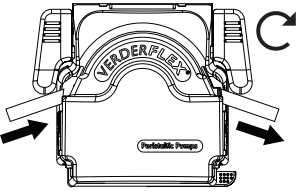
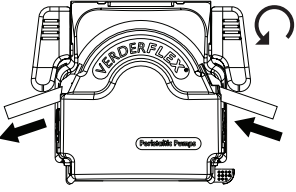
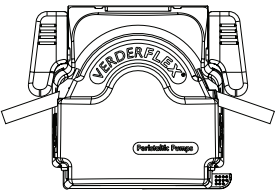
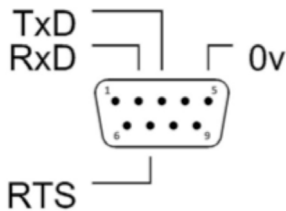

Figure 9: 25 way 'D' type connector

12.7.2 Connector Description:

PIN	FUNCTION
2	TRANSMIT DATA (TxD)
3	RECEIVE DATA (RxD)
5	0 VOLTS
7	REQUEST TO SEND (RTS)

Table 15: Digital Connector Pins

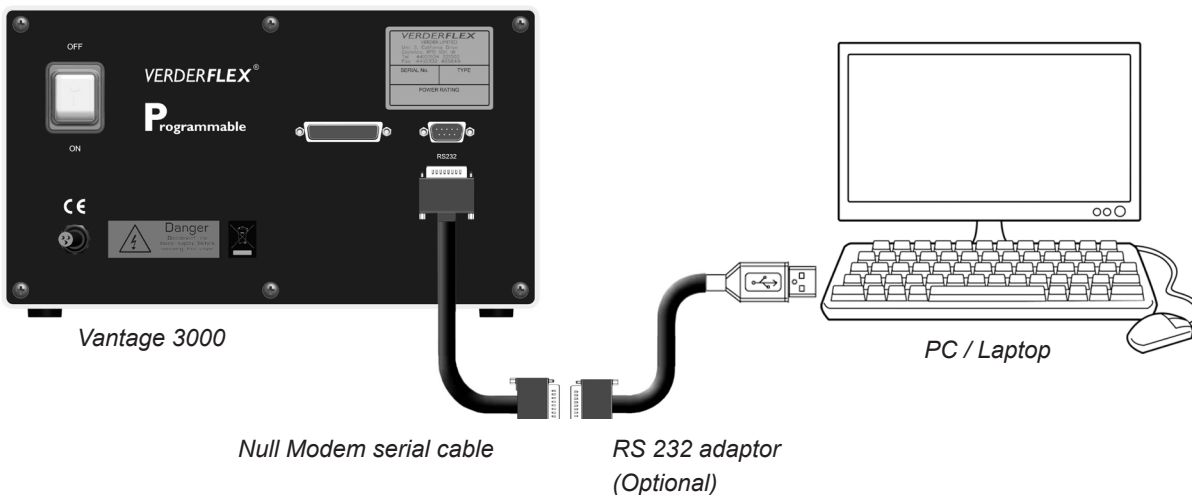

Figure 10: Connecting the footswitch

12.7.3 USB Driver installation and configuration

The USB/RS232 device drivers should be installed as per the manufacturer's guidelines prior to installing PCpump.exe. The pump should not be connected to your computer prior to installing the device drivers.

1. Connect the RS 232 adaptor to your USB port
2. Download and install driver software for the adaptor
3. Do not connect the RS232 cable to the RS232 adaptor until the following steps are completed
4. Copy the RS232 Software folder to your computer from disc
5. From your Windows™ “Control panel” open “Device Manager” and scroll down to “Ports (COM & LPT)”. If the drivers have installed successfully, you will see “USB Serial Port (COM xx)” (refer fig.12). Where xx = the com port number that the computer has assigned to the device. Make a note of this number. Click open “USB serial port” to access the properties dialogue. Click on the “Port settings” tab. Ensure that:-
 - a) bits per second =9600
 - b) Data Bits = 8
 - c) Parity = None
 - d) Stop bits =1
 - e) Flow control = None.
6. The folder on the disc supplied has a folder called “Vantage 3000 software” which contains 4 files:-
 - a) PCpumpreadme.docx (Instruction file)
 - b) PCpump.exe(Application)
 - c) PCpump.ini (Configuration setting)
 - d) PC pump Serial interface.doc (Communication Protocol)
7. Copy PCpump.exe to a directory of your choice.
8. Copy PCpump.ini to C:\WINDOWS. (This file must reside in the Windows root directory)
9. Click on the file PCpump.ini in your Windows root directory and edit the line “Port=xx” where xx = the port number you recorded earlier. E.g. Port=04. Save the edited file.

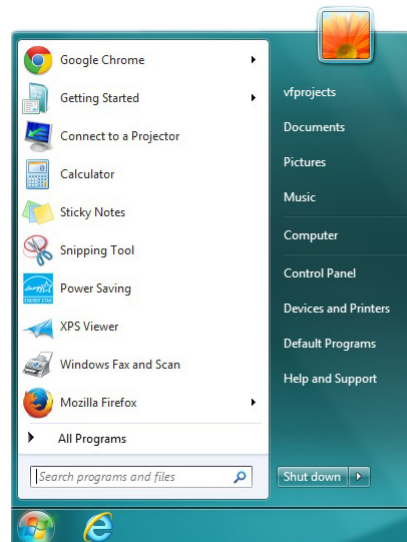

Figure 11: Opening the control panel



Figure 12: Opening “System settings”



Figure 13: Opening “Device manager”

10. If you are using an RS232 port on your computer to communicate with the pump you must also copy PCPUMP.ini to your windows root directory. In this case, the line Port=xx in PCPUMP.ini is not important or necessary.
11. With the USB/RS232 converter plugged into your computer run PCpump.exe. The program window should now appear. If the window appears repeatedly on screen, then the USB/RS232 converter has not installed correctly.
12. Connect a Null Modem serial cable between the USB/RS232 converter and the pump's RS232 DB9 socket. (it must be a Null modem cable not a standard "pin to pin" serial comm's cable)
13. The pump can now be controlled by your PC. Consult the Vantage 3000 Operation Manual for details on how to use this software utility.

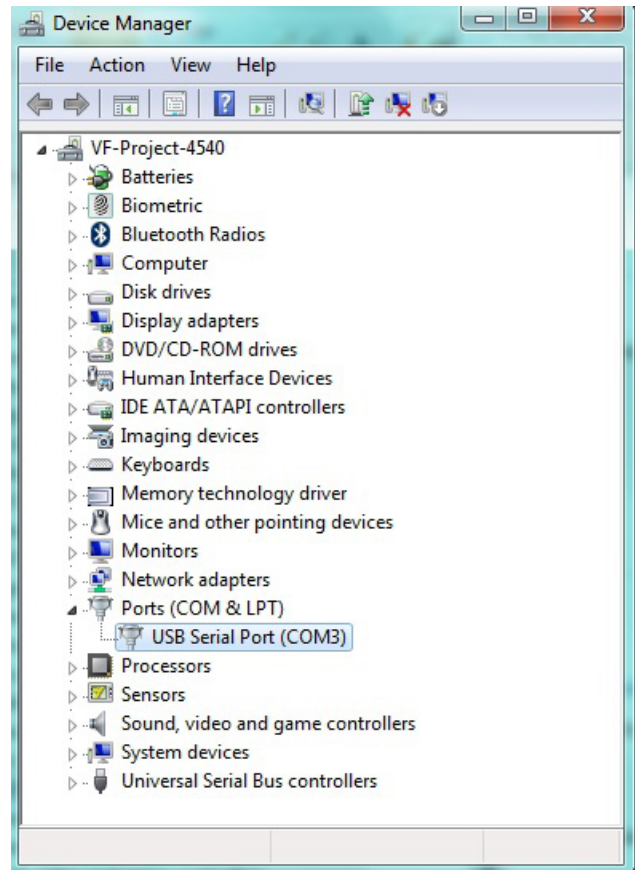

Figure 14: Opening "Port settings"

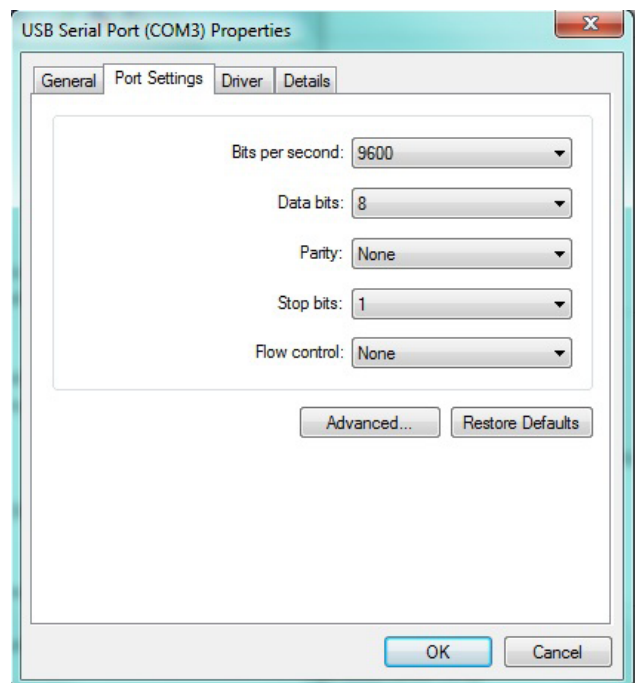

Figure 15: Opening "USB Serial port settings"

[PC pump Serial interface.doc](#) contains information for the control of the pump using ASCII code character strings. (Communications protocol)
Dated 01/09/2013

10. List of Figures and Tables

10.1 List of figures

<i>Figure 1: Tamper proof table</i>	6
<i>Figure 2: 25 way 'D' type connector (Remote control lead P/N: AU E1973)</i>	8.16
<i>Figure 3: IP66 Computer control</i>	11.2
<i>Figure 4: Back plate – Vantage 3000 P</i>	12.2
<i>Figure 5: Back plate – Vantage 3000 P</i>	12.2
<i>Figure 6: 25 way 'D' type connector</i>	12.4
<i>Figure 7: Connecting the footswitch</i>	12.5
<i>Figure 8: Connecting Variable Voltage/Current source</i>	12.6
<i>Figure 9: 25 way 'D' type connector</i>	12.7
<i>Figure 10: Connecting the footswitch</i>	12.7.2
<i>Figure 11: Opening the control panel</i>	12.7.3
<i>Figure 12: Opening "System settings"</i>	12.7.3
<i>Figure 13: Opening "Device manager"</i>	12.7.3
<i>Figure 14: Opening "Port settings"</i>	12.7.3
<i>Figure 15: Opening "USB Serial port settings"</i>	12.7.3

10.2 List of tables

<i>Table 1: Keypad Keys and symbols</i>	1
<i>Table 2: Keypad Key combinations</i>	1
<i>Table 3: Vantage 3000 P pump head options</i>	7.1
<i>Table 4: Installing the tube</i>	7.2.2
<i>Table 5: Replacing pump head – EZ head</i>	7.2.3
<i>Table 6: Stacking – EZ head</i>	7.2.4
<i>Table 7: Installing tube – S10 head</i>	7.3.1
<i>Table 8: Installing tube – R3i head</i>	7.4.2
<i>Table 9: Replacing the rotor – R3i head</i>	7.4.3
<i>Table 10: Analogue /Digital Remote Interface</i>	8.16
<i>Table 11: Models & Control features available</i>	12.3
<i>Table 12: Analogue/Digital Connector Pins</i>	12.4
<i>Table 13: Pin Function & Connection</i>	12.5.1
<i>Table 14: Pin connection for analogue control (refer table 2 for pin description)</i>	12.6.1
<i>Table 15: Digital Connector Pins</i>	12.7.2
<i>Table 16: Declaration of conformity according to EC Machine Directive</i>	13

13. Declaration of conformity according to EC Machine Directive



<p>EC declaration of conformity according to machine directive, appendix II A</p> <p>We, VERDER Ltd., Unit 3 California Drive, Castleford hereby declare that the following machine adheres to the relevant EC directives detailed below</p> <p>Designation Verderflex Vantage 3000 P EZ Verderflex Vantage 3000 P S10 Verderflex Vantage 3000 P R3i</p> <p>EC directives:</p> <ul style="list-style-type: none"> • Machine Directive (2006/42/EC) • Low-voltage directive (2006/95/EC) • EMC directive (2004/108/EC) <p>Applicable harmonized norms:</p> <ul style="list-style-type: none"> • EN ISO 12100: 2010 		
Responsible for the documentation	VERDER Ltd. Unit 3 California Drive Castleford WF10 5QH UK	
Date: 01/ 12/ 2013	Company stamp / signature:  David Sampson Head of Development/Construction	Company stamp / signature:  David Hoyland Head of Quality

Table 16 Declaration of conformity according to EC Machine Directive

